

Weight: 3.1 g [0.007 lb]

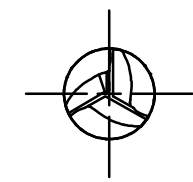

NO. OF FLUTES = 3
UNEQUAL SPACING

ER NUMBER		ER DESCRIPTION	
CHG DESCRIPTIONS			
MATERIAL		GRADE K600	
FIRST ANGLE PROJECTION		[INCHES] MILLIMETERS	
<p>NOTICE: THIS DRAWING IS THE PROPERTY OF KENNAMETAL INC. AND/OR A KENNAMETAL INC. SUBSIDIARY AND CONTAINS PROPRIETARY AND TRADE SECRET INFORMATION AND INTELLECTUAL PROPERTY RIGHTS. IT HAS BEEN SUBMITTED TO YOU IN CONFIDENCE FOR A SPECIFIC PURPOSE AND MAY ONLY BE USED FOR THAT PURPOSE. THE REPRODUCTION, DISTRIBUTION AND UTILIZATION OF THIS DRAWING, IN WHOLE OR IN PART, AS WELL AS THE COMMUNICATION OF ANY OF ITS CONTENTS TO OTHERS, WITHOUT EXPRESS WRITTEN AUTHORIZATION IS PROHIBITED. ALL RIGHTS RESERVED.</p>			
<p>7460884 7460884 HP ALUMINUM D1=3 D=3 AP=10</p>			
Drawn	LEVYU	2026-06-04	Scale
Checked			4 : 1
Approved			
Cust. Part#			
Cust. Dwg.#			
Quote No.			
Order No.			
Reference			
Type CONCEPT		Sheet 1 of 1	
DRAWING NUMBER		VER.	DWG SIZE
63491543.000		00	A3

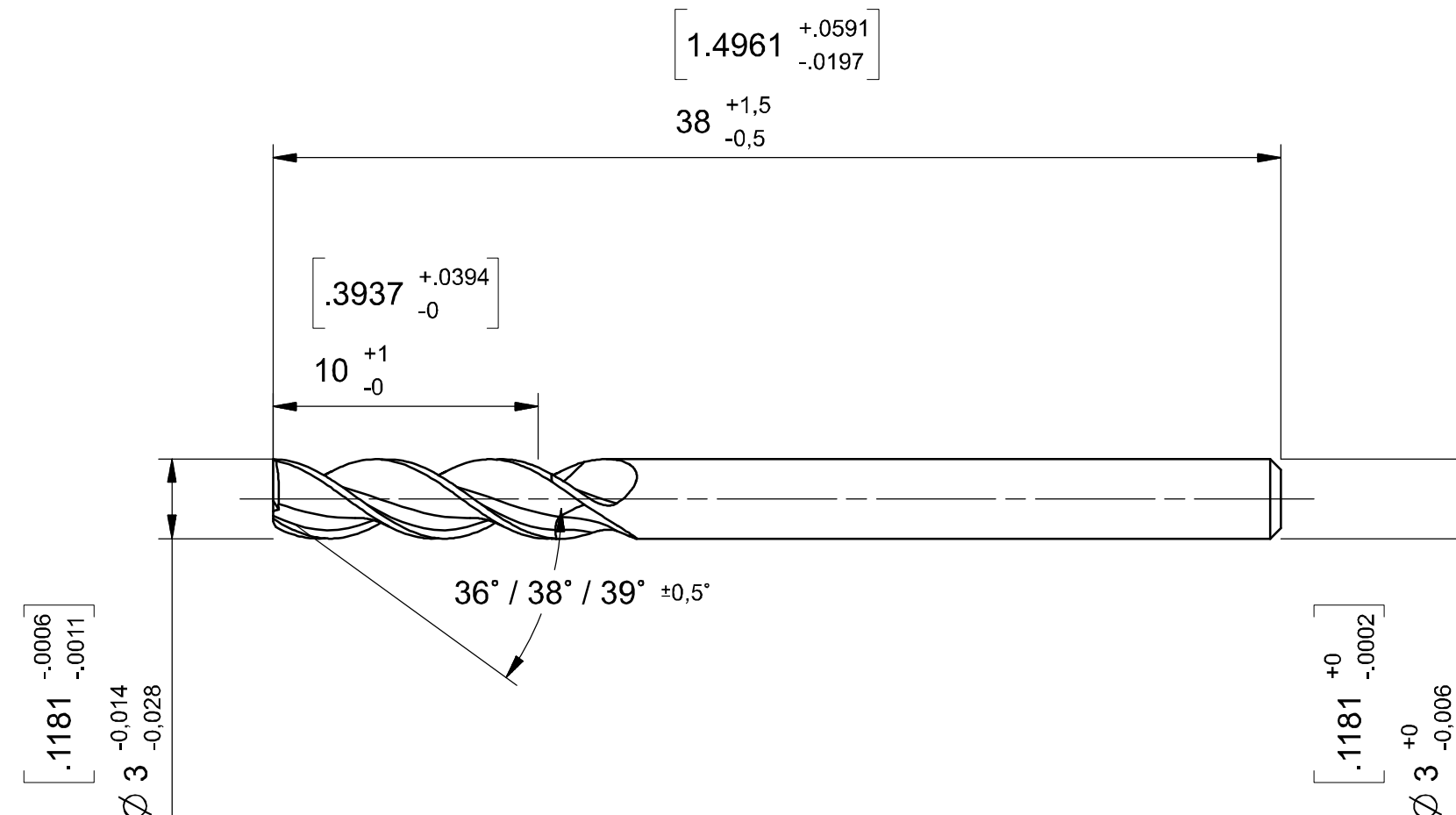